

## Nokia 8208 User Guide

---

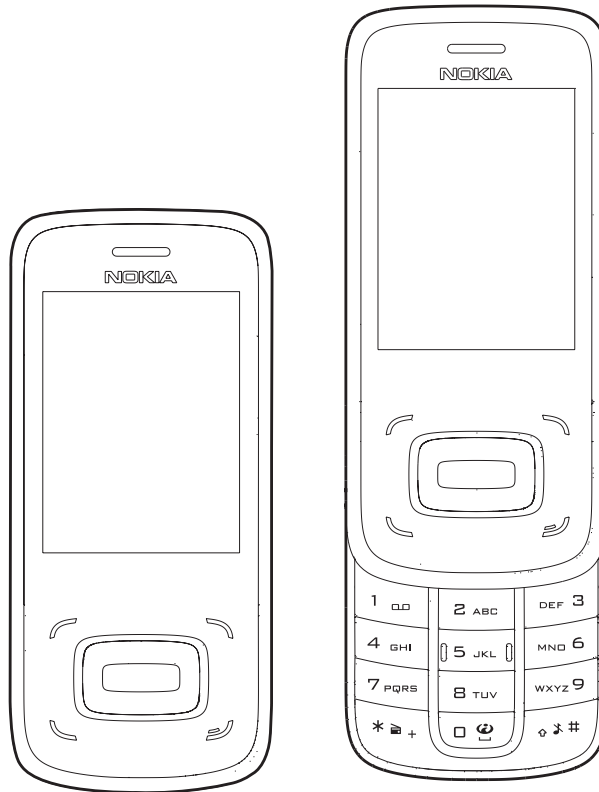

9210319  
Issue 1 EN

©2009 Nokia. All rights reserved.

Nokia, Nokia Connecting People, and Navi are trademarks or registered trademarks of Nokia Corporation. Nokia tune is a sound mark of Nokia Corporation. Other product and company names mentioned herein may be trademarks or tradenames of their respective owners.

Reproduction, transfer, distribution, or storage of part or all of the contents in this document in any form without the prior written permission of Nokia is prohibited.



Includes RSA BSAFE cryptographic or security protocol software from RSA security.

This product is licensed under the MPEG-4 Visual Patent Portfolio License (i) for personal and noncommercial use in connection with information which has been encoded in compliance with the MPEG-4 Visual Standard by a consumer engaged in a personal and noncommercial activity and (ii) for use in connection with MPEG-4 video provided by a licensed video provider. No license is granted or shall be implied for any other use. Additional information, including that related to promotional, internal, and commercial uses, may be obtained from MPEG LA, LLC. See <<http://www.mpegla.com>>.

The availability of particular products and applications and services for these products may vary by region. Please check with your Nokia dealer for details, and availability of language options.

Nokia operates a policy of ongoing development. Nokia reserves the right to make changes and improvements to any of the products described in this document without prior notice.

TO THE MAXIMUM EXTENT PERMITTED BY APPLICABLE LAW, UNDER NO CIRCUMSTANCES SHALL NOKIA OR ANY OF ITS LICENSORS BE RESPONSIBLE FOR ANY LOSS OF DATA OR INCOME OR ANY SPECIAL, INCIDENTAL, CONSEQUENTIAL OR INDIRECT DAMAGES HOWSOEVER CAUSED.

THE CONTENTS OF THIS DOCUMENT ARE PROVIDED "AS IS". EXCEPT AS REQUIRED BY APPLICABLE LAW, NO WARRANTIES OF ANY KIND, EITHER EXPRESS OR IMPLIED, INCLUDING, BUT NOT LIMITED TO, THE IMPLIED WARRANTIES OF MERCHANTABILITY AND FITNESS FOR A PARTICULAR PURPOSE, ARE MADE IN RELATION TO THE ACCURACY, RELIABILITY OR CONTENTS OF THIS DOCUMENT. NOKIA RESERVES THE RIGHT TO REVISE THIS DOCUMENT OR WITHDRAW IT AT ANY TIME WITHOUT PRIOR NOTICE.

#### Export controls

This device may contain commodities, technology or software subject to export laws and regulations from the US and other countries. Diversion contrary to law is prohibited.

The third-party applications provided with your device may have been created and may be owned by persons or entities not affiliated with or related to Nokia. Nokia does not own the copyrights or intellectual property rights to the third-party applications. As such, Nokia does not take any responsibility for end-user support, functionality of the applications, or the information in the applications or these materials. Nokia does not provide any warranty for the third-party applications.

BY USING THE APPLICATIONS YOU ACKNOWLEDGE THAT THE APPLICATIONS ARE PROVIDED



AS IS WITHOUT WARRANTY OF ANY KIND, EXPRESS OR IMPLIED, TO THE MAXIMUM EXTENT PERMITTED BY APPLICABLE LAW. YOU FURTHER ACKNOWLEDGE THAT NEITHER NOKIA NOR ITS AFFILIATES MAKE ANY REPRESENTATIONS OR WARRANTIES, EXPRESS OR IMPLIED, INCLUDING BUT NOT LIMITED TO WARRANTIES OF TITLE, MERCHANTABILITY OR FITNESS FOR A PARTICULAR PURPOSE, OR THAT THE APPLICATIONS WILL NOT INFRINGE ANY THIRD-PARTY PATENTS, COPYRIGHTS, TRADEMARKS, OR OTHER RIGHTS.

FCC NOTICE

Your device may cause TV or radio interference (for example, when using a telephone in close proximity to receiving equipment). The FCC can require you to stop using your telephone if such interference cannot be eliminated. If you require assistance, contact your local service facility. This device complies with part 15 of the FCC rules. Operation is subject to the following two conditions: (1) This device may not cause harmful interference, and (2) this device must accept any interference received, including interference that may cause undesired operation. Any changes or modifications not expressly approved by Nokia could void the user's authority to operate this equipment.

9210319/Issue 1 EN

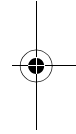
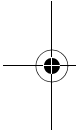

## Contents

<b>SAFETY</b> .....	<b>6</b>	Groups.....	31
<b>General information</b> .....	<b>9</b>	Speed dials.....	31
Access code .....	9	Service numbers.....	32
Getting help.....	9	Delete contacts entries .....	32
<b>1. Get started</b> .....	<b>10</b>	Move contacts .....	32
Insert battery and UIM card .....	10	Copy contacts.....	32
microSD card.....	12	<b>7. Log</b> .....	<b>33</b>
Charge the battery.....	13	<b>8. Settings</b> .....	<b>34</b>
Switch your device on or off .....	13	Profiles .....	34
Antenna .....	14	Display.....	34
Connect the headset.....	14	Themes .....	37
Wrist strap .....	15	Tones.....	37
<b>2. Your device</b> .....	<b>16</b>	Date and time settings.....	38
Keys and parts.....	16	My shortcuts .....	38
Standby mode .....	18	Call settings.....	39
Indicators and icons.....	19	Phone settings.....	40
Keyguard.....	19	Carrier settings .....	41
<b>3. Call functions</b> .....	<b>21</b>	Connectivity .....	41
Make and answer calls.....	21	Accessory settings .....	44
Speed dialling.....	22	Security settings.....	44
Loudspeaker.....	22	Network settings.....	45
<b>4. Write text</b> .....	<b>23</b>	Network services.....	45
English input .....	23	Restore factory settings.....	46
Enter special characters and punctuation marks .....	24	Phone details.....	46
<b>5. Messaging</b> .....	<b>25</b>	<b>9. Gallery</b> .....	<b>47</b>
Text messages .....	25	Gallery folders.....	48
Distribution lists.....	27	Memory card .....	48
Voice messages.....	27	Use files to personalise your device	48
E-mail messages.....	27	Work with files .....	48
<b>6. Contacts</b> .....	<b>30</b>	Memory Status .....	49
Names .....	30	<b>10. Camera</b> .....	<b>50</b>
Contacts settings .....	30	Capture an image .....	50
		Record a video clip .....	50
		Camera options .....	51
		<b>11. Media</b> .....	<b>53</b>



Music player .....	53	Voice Command Settings.....	63
Media player.....	55	<b>14.Extras.....</b>	<b>65</b>
Stereo FM radio.....	56	Games.....	65
Recorder.....	57	Collection.....	65
Audio effects.....	57	<b>15.Battery and charger</b>	
Speaker type.....	57	<b>information 66</b>	
<b>12.Organiser .....</b>	<b>58</b>	Nokia battery authentication	
Alarm clock.....	58	guidelines.....	67
Calendar.....	58	<b>Care and maintenance.....</b>	<b>69</b>
Notes .....	59	<b>Additional safety information</b>	<b>71</b>
To-do list.....	59	<b>Index .....</b>	<b>75</b>
Calculator.....	59		
Countdown timer.....	60		
Stopwatch.....	61		
<b>13.Voice commands .....</b>	<b>62</b>		
Activate and use voice commands.	62		

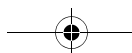
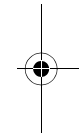
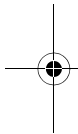

## SAFETY

---

Read these simple guidelines. Not following them may be dangerous or illegal. Read the complete user guide for further information.



### SWITCH ON SAFELY

Do not switch the device on when wireless phone use is prohibited or when it may cause interference or danger.



### ROAD SAFETY COMES FIRST

Obey all local laws. Always keep your hands free to operate the vehicle while driving. Your first consideration while driving should be road safety.



### INTERFERENCE

All wireless devices may be susceptible to interference, which could affect performance.



### SWITCH OFF IN RESTRICTED AREAS

Follow any restrictions. Switch the device off in aircraft, near medical equipment, fuel, chemicals, or blasting areas.



### QUALIFIED SERVICE

Only qualified personnel may install or repair this product.



### ACCESSORIES AND BATTERIES

Use only approved accessories and batteries. Do not connect incompatible products.



### WATER-RESISTANCE

Your device is not water-resistant. Keep it dry.

## About your device

The wireless device (RM-384) described in this guide is approved for use on the CDMA 800 and 1900 MHz, CDMA 2000 1xRTT, and EVDO networks. Contact your service provider for more information about networks.

When using the features in this device, obey all laws and respect local customs, privacy and legitimate rights of others, including copyrights.

Copyright protection may prevent some images, music, and other content from being copied, modified, or transferred.

## SAFETY

Your device may have preinstalled bookmarks and links for third-party internet sites. You may also access other third-party sites through your device. Third-party sites are not affiliated with Nokia, and Nokia does not endorse or assume liability for them. If you choose to access such sites, you should take precautions for security or content.



**Warning:** To use any features in this device, other than the alarm clock, the device must be switched on. Do not switch the device on when wireless device use may cause interference or danger.

Remember to make back-up copies or keep a written record of all important information stored in your device.

When connecting to any other device, read its user guide for detailed safety instructions. Do not connect incompatible products.

### ■ Network services

To use the device you must have service from a wireless service provider. Many of the features require special network features. These features are not available on all networks; other networks may require that you make specific arrangements with your service provider before you can use the network services. Using network services involves transmission of data. Check with your service provider for details about fees in your home network and when roaming in other networks. Your service provider can give you instructions and explain what charges will apply. Some networks may have limitations that affect how you can use network services. For instance, some networks may not support all language-dependent characters and services.

Your service provider may have requested that certain features be disabled or not activated in your device. If so, these features will not appear on your device menu. Your device may also have a special configuration such as changes in menu names, menu order, and icons. Contact your service provider for more information.

This device supports WAP 2.0 protocols (HTTP and SSL) that run on TCP/IP protocols. Some features of this device, such as media and e-mail messages require network support for these technologies.

### ■ Enhancements, batteries, and chargers



**Warning:** Use only batteries, chargers, and accessories approved by Nokia for use with this particular model. The use of any other types may invalidate any approval or warranty, and may be dangerous.



**SAFETY**



For availability of approved accessories, please check with your dealer. When you disconnect the power cord of any accessory, grasp and pull the plug, not the cord. Check the model number of any charger before use with this device.

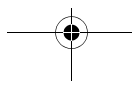
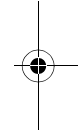
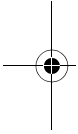



## General information

Congratulations on your purchase of the Nokia 8208 mobile device. It provides several functions for practical daily use, such as a hands-free loudspeaker, an alarm clock, a calculator, a calendar, and more. Your device can connect to a PC, laptop, or other device using a data cable. To personalise it, you can set your favourite ringing tones, wallpaper, screensaver, and other features.

### ■ Access code

The PIN code protects your UIM card from unauthorised access. The PIN code can be 4 to 8 digits in length. The default PIN code may vary depending on your wireless service provider.

After three successive incorrect entries, the PIN code is blocked. To unblock it, you must enter your Personal Unblocking Key (PUK) code.

To configure access code settings, select **Menu > Settings > Security**, enter your default lock code, select **OK** and from the available options.

If you forget the code and your device is locked, your device will require service and additional charges may apply. For more information, contact a Nokia Care point or your device dealer.

### ■ Getting help

#### Nokia support on the web

Check [www.nokia.com/support](http://www.nokia.com/support) or your local Nokia website for the latest guides, additional information, downloads, and services related to your Nokia product.

Get started

## 1. Get started

### ■ Insert battery and UIM card

#### Remove the back cover and battery



Note: Always switch off the power and disconnect the charger and any other device before removing the cover. Avoid touching electronic components while changing the cover. Always store and use the device with the cover attached.

1. Press the back cover release button on the top of the device.

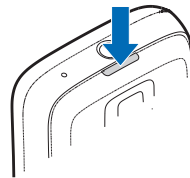

2. Lift the back cover off carefully.

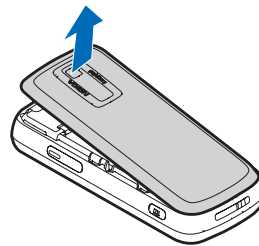

3. Lift the battery up from its compartment.

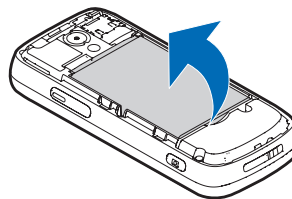

Get started

### Install the UIM card

The user identity module (UIM) card can be easily damaged by scratching or bending, so be careful when handling, inserting, or removing it. The UIM card slot is located under the battery. Keep the UIM card out of the reach of small children.

1. Slide forward the card holder and lift it from the holder.
2. Hold the bevelled corner of the UIM card facing up and aligned with the bevelled corner of the card holder.

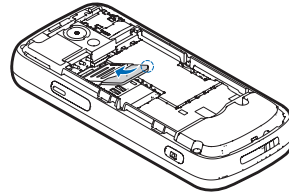

3. Insert the UIM card into the holder with the gold-coloured contacts facing down, matching up with the gold-coloured contacts on the device.

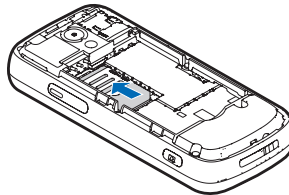

4. Slide back the card holder and lock it into place.

### Replace the battery and back cover

1. Insert the battery, gold-coloured contact end first, into the battery slot.
2. Push down on the other end of the battery to snap it into place.

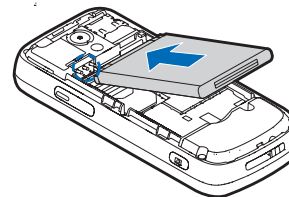

Get started

3. Replace the back cover so that the cover tabs align with the slots in the device. Press the cover down gently until it clicks into place.

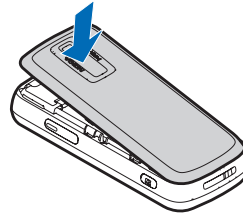

■ microSD card

Use only compatible microSD cards approved by Nokia for use with this device. Your device supports microSD cards up to 16 GB. Nokia uses approved industry standards for memory cards, but some brands may not be fully compatible with this device. Incompatible cards may damage the card and the device and corrupt data stored on the card.

To insert the microSD card:

1. Remove the back cover.
2. Lift open the microSD holder cover.
3. Slide the card into the holder carefully with the gold-coloured contacts facing down, and close the cover.
4. Replace the cover.

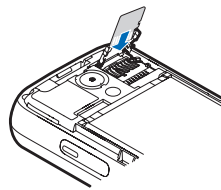
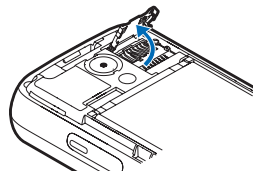

Get started

 **Important:** Do not remove the memory card in the middle of an operation when the card is being accessed. Removing the card in the middle of an operation may damage the memory card as well as the device, and data stored on the card may be corrupted.

**■ Charge the battery**

Your battery has been precharged, but the charging levels may vary.

1. Connect the charger to a wall outlet.
2. Connect the charger to the device. You can use your device while it is charging.
3. When the battery is fully charged, disconnect the charger from the device, then from the wall outlet to save energy.

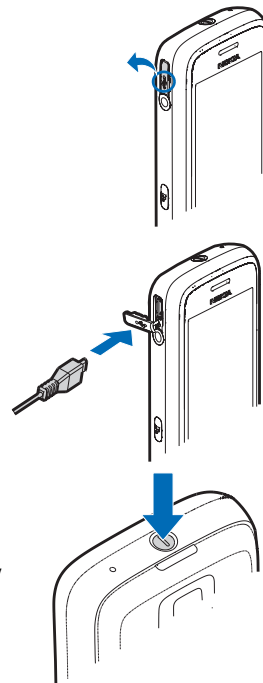

**■ Switch your device on or off**

1. Press and hold the end key for at least 4 seconds.
2. Enter the lock code or PIN code, if necessary, and select **OK**. See "Security settings", p. 44.

Get started

**Antenna**

Your device may have internal and external antennas. As with any radio transmitting device, avoid touching the antenna area unnecessarily while the antenna is transmitting or receiving. Contact with such an antenna affects the communication quality and may cause the device to operate at a higher power level than otherwise needed and may reduce the battery life.



**Connect the headset**

Do not connect products that create an output signal as this may cause damage to the device. Do not connect any voltage source to the Nokia AV Connector.

When connecting any external device or any headset, other than those approved by Nokia for use with this device, to the Nokia AV connector, pay special attention to volume levels.

A compatible headset may be purchased with your device or separately as an accessory. See "Accessory settings", p. 44.

1. Plug the headset connector into the connector on the side of your device.  appears on the screen.
  2. Position the headset on your ear.
- With the headset connected, you can make, answer, and end calls as usual.

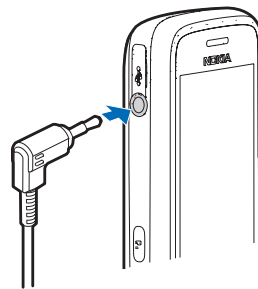

Get started



**Warning:** When you use the headset, your ability to hear outside sounds may be affected. Do not use the headset where it can endanger your safety.

■ **Wrist strap**



**Note:** The wrist strap does NOT come in the box.

Thread the wrist strap, and tighten it.

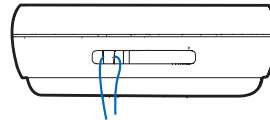

Your device

## 2. Your device

### ■ Keys and parts

1. Earpiece
2. Display screen
3. Right selection key
4. Navi™ key; hereafter referred to as scroll key
5. End key
6. Keypad
7. Silent key – Press and hold to turn on the Silent profile.
8. Wireless internet key – Press and hold to access internet services.
9. Radio key – Press and hold to turn on the radio.
10. Call key
11. Middle selection key
12. Left selection key

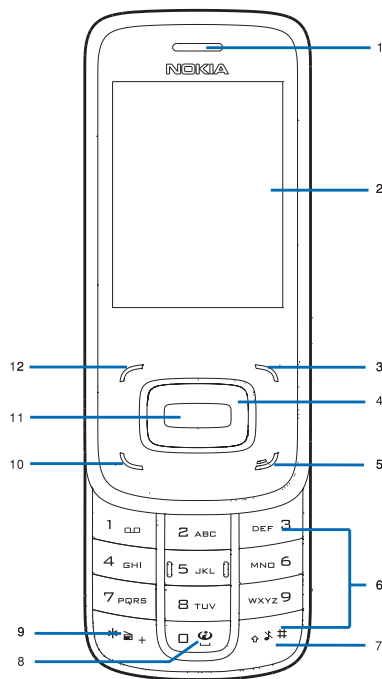



Your device

- 13.Voice command key
- 14.Headset connector
- 15.Charger/USB port
- 16.Microphone
- 17.Power button
- 18.Back cover release button
- 19.Camera lens
- 20.Camera flash

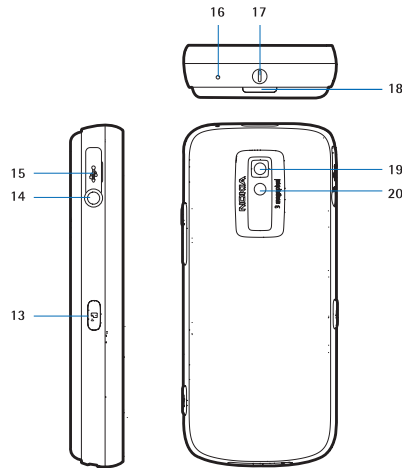

- 21.Rewind key – Press to play the previous song in your playlist, or press and hold to rewind through the current song.
- 22.Play/Pause key – Press to play or pause a song in your playlist.
- 23.Fast forward key – Press to play the next song in your playlist, or press and hold to fast-forward through the current song.
- 24.Volume/Zoom key – Press to control audio volume or to zoom

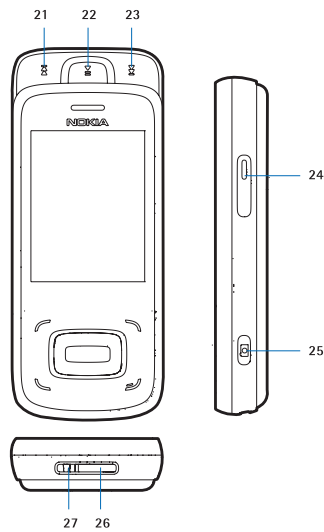

### Your device

when you are using the camera.

- 25. Camera button
- 26. Microphone
- 27. Wrist strap eyelet

### ■ Standby mode

Depending on your wireless service provider and the model number of your device, some or all of the following indicators and shortcut keys may be available in the standby mode.

#### Home screen

The home screen indicates that your device is in the standby mode.

1. Signal strength – The number of bars indicates the strength of the signal received by the device.
2. Battery strength – A full bar indicates a fully charged battery.
3. Time – The time of day is displayed.
4. **Names** – Press the right selection key to access your contacts list.
5. **Menu** – Press the middle selection key to access the main menus.
6. **Go to** – Press the left selection key to access a list of your favourite applications. To add items to the list, select **Add** and from the available options.
7. Active standby – See "Active standby", p. 18.

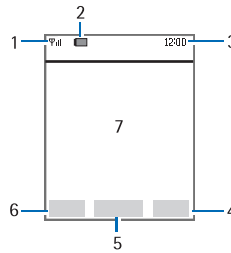

#### Active standby

The active standby displays a list of selected device features and information that you can directly access, such as application shortcuts,

## Your device











information from the radio and music player, calendar events, and a customisable note.

To switch active standby on or off, select **Menu** > **Settings** > **Display** > **Active standby** > **Active standby mode** > **On** or **Off**.

To view or customise the active standby key, see "Configure active standby", p. 35. In the standby mode, select the active standby key to activate the navigation, then scroll up or down in the list, and choose **Select** or **View**. To stop navigation, select **Exit**. To organise and change the active standby, select **Options** and from the available options. If no keys are pressed in a certain time, the device automatically deactivates the navigation.

## ■ Indicators and icons

Depending on your wireless service provider and the model number of your device, some or all of the following indicators and icons may be available in the standby mode and active standby mode.

-  An alarm is set. See "Alarm clock", p. 58.
-  A headset is connected to the device. See "Accessory settings", p. 44.
-  Your device keypad is locked. See "Keyguard", p. 20.
-  The loudspeaker is on.
-  Your device is set to the *Silent* profile. See "Profiles", p. 34.
-  The stopwatch timer is running in the background.
-  You have new text messages. See "Text messages", p. 25.
-  You have new voice messages. See "Voice messages", p. 27. This icon shows only when the network supports this function.
-  The countdown timer.
-  The current profile is timed. See "Profiles", p. 34.



## Your device

### ■ Keyguard

With the keyguard, you can lock the keypad to prevent accidental keypresses. When the keypad is locked, it unlocks if you receive a call. When the call ends, it is automatically locked again.

To set the keypad to lock automatically when the device is in the standby mode and no function of the device has been used for a certain time, select **Menu** > **Settings** > **Phone** > **Automatic keyguard** > **On**.

To lock the keypad manually, select **Menu**, and press \* within 4 seconds.

When the keyguard is on, calls may be possible to the official emergency number programmed into your device.

To unlock the keypad, select **Unlock**, and then press \* within 4 seconds.

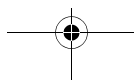
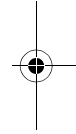
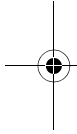

## 3. Call functions

### ■ Make and answer calls

#### Make a call

To make a call, enter the phone number, including the country code and area code, if necessary. To delete a character, press **Clear**. Press the call key to call the number. Use the volume keys to adjust the volume of the earpiece or headset during the phone call. To end the call, press the end key.

#### Use voice commands to make a call

To start voice dialling, press and hold the voice command key. If a compatible headset with a headset key is attached, press and hold the headset key to start voice dialling. A short tone sounds and the device prompts you to say a command. Say clearly the name or number that is saved in your contacts list. If the recognised contact was not correct, press the end key to end the call, and try again. See "Activate and use voice commands", p. 62.

#### Make a conference call

Conference calling (network service) allows you to take part in a conference call with two other participants. During a call, to make a call to a new participant, select **Options > New call**. Enter the number you want, and press the call key. When the new call is answered, press the call key to connect the calls. To end the conference call, select **Options > End all calls**, or press the end key.

#### Answer or reject a call

To answer an incoming call, press the call key. To reject the call without answering, press the end key.

## Call functions

### ■ Speed dialling

Press and hold the assigned number key, 2-9, to start speed dialling one of your contacts.

To use this feature, you need:

- Assign a speed dialling number key to the desired contact, see "Speed dials", p. 31.
- Turn on the speed dial feature, see "Call settings", p. 39.

### ■ Loudspeaker

You can use your device as a loudspeaker during a call.



**Warning:** Do not hold the device near your ear when the loudspeaker is in use, because the volume may be extremely loud.

To activate the loudspeaker during a call, select **Loudsp.**

To deactivate the loudspeaker during a call, select **Normal.**

The loudspeaker is deactivated automatically when a call (or a call attempt) ends or when certain accessories are connected.



Write text

## 4. Write text

### ■ English input

To enter English, you can use either standard or predictive English input.

To switch between the standard English and predictive English input modes, select **Options** > **Prediction options** > **Prediction** > **On** or **Off**.

To switch the text input method between uppercase , lowercase , and sentence case , press # repeatedly.

To enter a number, press and hold # and select **Number mode**.

### Standard English input

- Press a number key from 2 to 9 to enter the first letter on the key, twice to enter the second letter, and so on.  
If the next letter is located on the same key as the current one, wait until the cursor appears.
- Press **Clear** to delete one letter to the left of the cursor. Press and hold **Clear** to delete letters quickly.
- To insert a space, press 0.

### Predictive English input

With predictive English input, you can use the built-in dictionary when writing, and add new words to it. You can use predictive English input only when the writing language is English.

1. Start writing a word using the keys from 2 to 9. Press each key once for each letter.

The following example shows what is displayed when you write "Nokia" using predictive English input. Press 6-6-5-4-2.

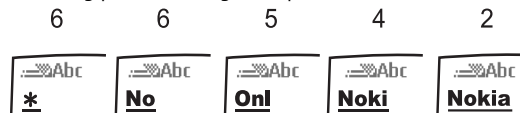



#### Write text



2. Press **O** to confirm a word and insert a space after it.

If the word is not correct, press **\*** repeatedly until the desired word appears, and then confirm.

If **\*** appears, enter an additional key to make a match with the built-in dictionary.

If the **?** character is displayed after the word, the word you intend to write is not in the dictionary. To add the word to the dictionary, select **Spell**. Enter the word using standard English input, and select **Save**.

#### ■ Enter special characters and punctuation marks

If you are using the standard English or number mode, press **\*** to view the list of special characters and punctuation marks. Scroll to the one you want, and select **Use**.

If you are using the standard English input mode, press **1** repeatedly to enter frequently used punctuation marks.

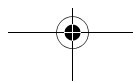
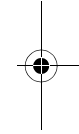
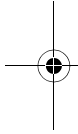



## 5. Messaging



If you have subscribed to a messaging network service, you can send and receive messages between compatible mobile devices that also subscribe to a messaging service. You can also exchange e-mail. Messaging features are network services.



**Note:** The message sent icon or text on your device screen does not indicate that the message is received at the intended destination.

### ■ Text messages

#### Write and send a text message

1. Select **Menu** > **Messaging** > **Text messages** > **Create message**.
2. Scroll to the **To:** field, and enter the recipient's phone number.
3. Scroll to the **Message:** field, and write a message.

An indicator at the top of the display shows the total number of characters left.

4. Scroll down, and select **Send**.

Messages are automatically stored in the Sent folder as they are sent. If your service is interrupted while sending, the message is stored in the Outbox folder until another delivery attempt is made.

#### Read and reply to a text message

When you receive a message, a notification and  are displayed. Select **Show** to read the message, or **Exit** to dismiss the notification and read the message later from the Inbox folder. If necessary, scroll up or down to view the whole message.

With the message open, select **Reply** to write your reply, and select **Send**.

## Messaging

### Delete text messages

You must delete unlocked messages when your message memory is full. To lock or unlock the message, select **Menu > Messaging > Text messages** > the folder containing the message, the desired message, and select **Options > Lock** or **Unlock**.

### Delete a single message

1. Select **Menu > Messaging > Text messages**.
2. Select the folder containing the message you want to delete.
3. Scroll to the message you want to delete, and select **Options > Delete > Yes**.

### Delete all messages in a folder

1. Select **Menu > Messaging > Text messages > Delete messages**.
2. Select **All**, **All read**, or **All unread** to indicate which messages to delete in a folder.
3. Scroll to each folder that has messages you want to delete, and select **Mark > Done > Yes**, or select **Options > Mark all > Done > Yes**.

### Text message settings

You can configure text message settings to personalise your message format, and contents of the Inbox and Outbox folders.

Select **Menu > Messaging > Text messages > Message settings > Sending options** and from the following:

**Priority** – The recipient views an alert icon for urgent messages (compatible Nokia devices only).

**Delivery reports** – Set the system to send a delivery report to the Inbox folder each time you send a message.

**Send callback number** – Assign a number to attach to each message.

**Signature** – Append a signature to each message.

Select **Menu > Messaging > Text messages > Message settings > Other settings** and from the following:

**Sv. incoming text msgs.** – Select where to save incoming messages.

## M e s s a g i n g

*Message font size* – Select a font size.

*Message overwriting* – Automatically replace old messages in the Inbox and Sent items folders when new ones arrive if the message memory is full.

*Save sent messages* – Select whether to save sent messages.

*Queue if no digital* – Select whether to store messages in the Outbox folder until they can be sent with digital service.

### ■ Distribution lists

You can send text messages quickly and conveniently to a list of contacts. To create and edit lists, select **Menu** > *Messaging* > *Distribution lists* and from the available options.

### ■ Voice messages

Voice mail is a network service that allows you to listen to voice messages recorded in the voice mail box. For more information, contact your service provider.

To enter, view or edit your voice mailbox number, select **Menu** > *Messaging* > *Voice messages* > *Voice mailbox no.*

### Listen to voice messages

When you receive a voice message, your device beeps, displays **VM**, or both. If you receive more than one voice message, your device shows the number of voice messages received. Select **Listen** to listen to the message, or **Exit** to dismiss the notification.

To dial the voice mailbox number, in the standby mode, press and hold **1**, or select **Menu** > *Messaging* > *Voice messages* > *Listen to voice msgs.* Follow the instructions to listen to your voice messages.

### ■ E-mail messages

The e-mail application uses a packet data connection (network service) to allow you to access your e-mail account from your device when you are not in the office or at home. To use the e-mail function on your

## Messaging

device, you need a compatible e-mail system. Your device supports POP3 and IMAP4 e-mail servers.

Before you can send and retrieve any e-mail messages, you must obtain a new e-mail account or use your current account.

You can set up a maximum of five e-mail accounts on your device. Each account is stored as a separate mailbox.

### Set up a mailbox

Select **Menu** > **Messaging** > **E-mail message** > **Settings** > **Options** > **New account** and from the following:

**Account name** – Enter a name for your mailbox.

**Protocol** – Select the protocol recommended by your service provider.

**User name** – Enter the user name of your e-mail address (username@domainname).

**Password** – Enter a password. If you leave this field blank, you are prompted for the password when you try to connect to your remote mailbox.

**Incom. domain name** – Enter the IP address or host name of the mail server that receives your mail.

**Incoming port** – Define a port for incoming mail.

**SMTP domain name** – Enter the IP address or host name of the mail server that delivers your mail.

**Outgoing SMTP port** – Define a port for outgoing mail.

**E-mail address** – Enter your e-mail address.

**Save on server** – Save recently received messages on the server.

**Receive unread only** – Your mailbox receives unread messages only.

**Download** – Read downloaded messages on your device, or view downloaded titles and read the complete messages online.

**Maximum size per mail** – Define the maximum size per mail

### Retrieve e-mail messages

Select **Menu** > **Messaging** > **E-mail message** > **Inbox** > **Options** > **Receive**, and an account. If you have not saved the password for the account, enter the password. If the account is not active, select **Yes** to activate the account and receive e-mail.

### E-mail message settings

To activate, connect to, edit, or delete a mailbox, select **Menu** > **Messaging** > **E-mail message** > **Settings**, a mailbox, **Options** and from the available options.

### Write and send an e-mail message

1. Select **Menu** > **Messaging** > **E-mail message** > **New e-mail**.
2. Scroll to the **To**; **Cc**; or **Bcc**: fields, and either enter e-mail addresses directly, or select **Add** > **Recently used** or **Contacts**.
3. Scroll to the **Subject**: field and enter a title.
4. Scroll to the **Message**: field and write a message with the keypad.
5. Select **Options** > **Send**.

### Read and reply to an e-mail message

To read an e-mail message, select **Menu** > **Messaging** > **E-mail message** > **Inbox**, and the message.

To reply to the message, select **Reply** > **Yes** to quote the original message, or **Reply** > **No** to start with a blank message.

## C o n t a c t s

## 6. Contacts



### ■ Names

You can access and add to the list of contacts and caller groups saved on your device, UIM card, or both.

#### Add new contacts

Select **Menu** > **Contacts** > **Names** > **Add** (if the list is empty) or **Options** > **Add new contact**, enter the name and phone number, and select **Save**.

#### Search for a contact

Select **Menu** > **Contacts** > **Names**, enter the first letters of the name you are searching for, scroll to the desired contact, and select **Details**.

#### Edit contacts entries

Select **Menu** > **Contacts** > **Names**, scroll to the entry you want to edit, and select **Options** > **Edit contact**.

#### Business cards

You can send and receive contacts as business cards via text messages, e-mail messages, or Bluetooth. Select **Menu** > **Contacts** > **Names**, scroll to the desired contact, and select **Details** > **Options** > **Send bus. card**.

### ■ Contacts settings

Select **Menu** > **Contacts** > **Settings** and from the following options:

**Memory in use** – Select where to store your contacts.

**Contacts view** – Select how the names and numbers in Contacts are displayed.

**Name display** – Select whether the contact's first or last name is displayed first.

**Font size** – Set the font size for the list of contacts.

## Contacts

**Memory status** – View the free and used memory capacity.

### ■ Groups

To identify callers, you can add contacts to caller groups, and assign a unique ringing tone or graphic to each group.

#### Create and edit caller groups

To create new caller groups, select **Menu > Contacts > Groups > Add** (if the list is empty), or **Options > Add new group**, enter details for the group, and select **Save**.

To edit group name, image and tone, scroll to a group and select **Options > Group details**.

To delete a group, scroll to the group and select **Options > Delete group > Yes**.

#### Add a contact to a group

Select **Menu > Contacts > Groups**, a group, and **View > Add**.

#### Remove a contact from a group

Select **Menu > Contacts > Groups**, a group, and **View**, scroll to the contact you want to remove, and select **Options > Remove member > Yes**.

### ■ Speed dials

You can associate a number key from 2 to 9 with an entry in the contacts list. To activate or deactivate speed dialling, see "Call settings", p. 39.

#### Assign a key to speed dialling

Select **Menu > Contacts > Speed dials**, scroll to an empty speed dialling slot, and select **Assign > Search** and the desired contact.

If speed dialling is off, the device prompts you to turn speed dialling on.

## C o n t a c t s

### Change speed dialling numbers

Select **Menu** > **Contacts** > **Speed dials**, scroll to the assigned speed dialling slot, and select **Options** > **Change** > **Yes** > **Search** and the desired contact.

### Delete speed dialling numbers

Select **Menu** > **Contacts** > **Speed dials**, scroll to the assigned speed dialling slot, and select **Options** > **Delete** > **Yes**.

### ■ Service numbers

Your UIM card may include preinstalled service numbers of your service provider (network service). To call a service number, select **Menu** > **Contacts** > **Service numbers**.

### ■ Delete contacts entries

To delete all entries in your contacts list, select **Menu** > **Contacts** > **Del. all contacts** > **From phone memory** or **From UIM card** > **Yes**, enter your lock code, and select **OK**.

### ■ Move contacts

To move contacts between the device memory and the UIM card, select **Menu** > **Contacts** > **Move contacts**.

### ■ Copy contacts

To copy contacts between the device memory and the UIM card, select **Menu** > **Contacts** > **Copy contacts**.



Log

## 7. Log

Call register stores information about your recent missed, received, and dialled calls. Select **Menu > Log** and from the following:

**Master log** – View a list of all calls in chronological order.

**Call log** – View a list of dialled, missed, and received calls in chronological order.

**Missed calls** – View a list of calls that have not been answered.

**Received calls** – View a list of calls that have been answered.

**Dialled numbers** – View a list of numbers that have been dialled.

**Msg. recipients** – View a list of recent message recipients.

**Clear log lists** – Clear any or all of the log lists.

**Call duration** – View the duration of the last call, all received calls, all dialled calls, or all calls. To reset the timers, select **Clear timers**, enter your lock code, and select **OK**.

**Data/fax calls** – View details of data or fax calls.

Settings

## 8. Settings

### ■ Profiles

A profile defines how your device reacts when you receive a call, select **Menu** > **Settings** > **Profiles** > the desired profile and from the available options.

**Activate** – Use the profile.

**Personalise** – Set the profile tones, alerts, volumes, and more. Scroll down to each option, and scroll left or right to change the default setting.

**Timed** – Set the profile to end after a certain time (not available for the Flight profile). Enter the time in HH:MM format.



**Warning:** With the flight profile you cannot make or receive any calls, including emergency calls, or use other features that require network coverage. To make calls, you must first activate the device function by changing profiles. If the device has been locked, enter the lock code. If you need to make an emergency call while the device is locked and in the flight profile, you may be also able to enter an official emergency number programmed in your device in the lock code field and select 'Call'. The device will confirm that you are about to exit flight profile to start an emergency call.

### ■ Display

To modify the look and feel of the phone display, select **Menu** > **Settings** > **Display**.

#### Wallpaper

Select **Menu** > **Settings** > **Display** > **Wallpaper** and from the following:

**Image** – Use a saved image from Gallery as a wallpaper for the active profile. See "Gallery", p. 47.

**Image format** – Edit the currently active wallpaper.

## Settings

**Slide set** – Go to folders in Gallery, and select images to show as a slide show.

**Open Camera** – Capture an image with the camera to use as a wallpaper.

**Graphic downloads** – Use a downloaded image on your device as a wallpaper for the active profile.

**On or Off** – Activate or deactivate the wallpaper.

### Configure active standby

See "Active standby", p. 18. Select **Menu > Settings > Display > Active Standby** and from the following:

**Active standby mode** – Turn the active standby mode on or off.

**Personalise view** – Select the content displayed in the active standby mode. Scroll to a content field, and select **Change** or **Assign** to personalise the content. To move the content, or to select and organise shortcuts for a shortcut bar, select **Options** and from the available options.

**Active standby key** – Select a shortcut key to turn the active standby mode on or off. You can also configure the active standby key when setting shortcuts. See "My shortcuts", p. 38.

### Set the standby mode font colour

Select **Menu > Settings > Display > Standby font colour** and from the available colours.

### Navigation key icons

To turn navigation key icons on or off, select **Menu > Settings > Display > Navigation key icons**.

### Set the display brightness

Select **Menu > Settings > Display > Display brightness** and a brightness level.

## Settings

### Set the banner

To enter text or assign a logo to display as a banner in the standby mode, or to use the default banner, select **Menu > Settings > Display > Banner** and from the available options.

### Set and edit a screen saver

Select **Menu > Settings > Display > Screen saver** and from the following:

**Image** – Use a saved image from Gallery as a screen saver. See "Gallery", p. 47.

**Image format** – Edit the currently active screen saver.

**Slide set** – Go to Gallery, and select images to show as a slide show.

**Video clip** – Use a saved video clip from Gallery as a screen saver. See "Gallery", p. 47.

**Open Camera** – Capture an image with the camera to use as a screen saver.

**Analogue clock** – Set a traditional clock as the screen saver.

**Digital clock** – Set a digital clock as the screen saver.

**Time-out** – Set the length of time the device is inactive before the screen saver is displayed.

**On or Off** – Activate or deactivate the screen saver.

### Use the power saver

To activate the power saver, select **Menu > Settings > Display > Power saver > On**. A clock is displayed when the phone is not used for a certain time.

### Use sleep mode

To activate the sleep mode, select **Menu > Settings > Display > Sleep mode > On**. The display turns off when the phone is not used for a certain time.

### Set the backlight time-out

To conserve battery life, you can set the phone backlighting to dim when idle. To set the backlight duration, select **Menu** > **Settings** > **Display** > **Backlight time-out** > **Default** or **Personalise**, and enter a time in MM:SS format.

### Set slide animation

To set whether an animation displays when you open or close the slide. Select **Menu** > **Settings** > **Display** > **Slide animation** > **On** or **Off**.

## ■ Themes

Selecting a theme automatically loads a wallpaper, screen saver, default ringing tone and background image for that theme.

To select a theme, select **Menu** > **Settings** > **Themes** > **Select theme**, and a theme.

To download a theme, select **Menu** > **Settings** > **Themes** > **Theme downloads** > **Add**, and enter the web address to download from and the title of the theme.

## ■ Tones

You can adjust the ringing volume and configure ringing tones, the vibrating alert, keypad tones, and more for the active profile.

If you select the highest ringing tone level, the ringing tone reaches its highest level after a few seconds.

Select **Menu** > **Settings** > **Tones** and from the following:

**Incoming call alert:** – Select a tone type, or turn incoming call alert off.

**Ringing tone:** – Download a ringing tone, use a ringing tone from Gallery, or use the Nokia tune ringing tone.

**Ringing volume:** – Select the volume for ringing tones.

**Light effects:** – Turn light effects on or off.

**Incoming call video:** – Select a file from Gallery, or turn incoming call video off.

## Settings

**Vibrating alert:** – Turn vibrating alert on or off.

**Message alert tone:** – Select the alert type for incoming messages.

**Keypad tones:** – Select the volume for the tone played when you press a key.

**End of list tone:** – Select whether to play a tone when you scroll to the end of a list.

**Other tones:** – Turn other tones on or off.

**Application tones:** – Turn application tones on or off.

**Alert for:** – Select which calls and other events the device alerts you for.

### ■ Date and time settings

To modify the date and time settings, select **Menu > Settings > Date and time** and from the following:

**Date and time settings** – Set the date and time.

**Date and time format** – Select the format for the date and time displays. You can select the order in which year, month, and date are displayed, and select the 24-hour or 12-hour format for the clock. You can also show or hide the date and time displays.

**Auto-update of time** – Set whether the device updates the time automatically by connecting to the network.

### ■ My shortcuts

#### Left selection key

To assign a shortcut function to the left selection key, select **Menu > Settings > My shortcuts > Left selection key**, and from the available options.

#### Right selection key

To assign a shortcut function to the right selection key, select **Menu > Settings > My shortcuts > Right selection key**, and from the available options.

### Navigation key

To select shortcut functions for the scroll key, select **Menu** > **Settings** > **My shortcuts** > **Navigation key**, scroll to the desired scroll key, and select **Change** and from the available options.

To remove the shortcut function from a key, in the navigation key menu, scroll to the desired key, and select **Change** > **(empty)**.

To reassign a function to a key, in the navigation key menu, scroll to the desired key, and select **Assign** and from the available options.

You cannot assign a function to the designated active standby key (either up or down key).

If both up and down scroll keys are set as the active standby key, assigning a function to either of them will automatically lock the other one as the active standby key.

### Active standby key

To select the key or keys to access the active standby mode, select **Menu** > **Settings** > **My shortcuts** > **Active standby key** > **Navigation key up**, **Navigation key down**, or **Nav. key up/down**.

### ■ Call settings

To customise how your device handles incoming and outgoing calls, select **Menu** > **Settings** > **Call** and from the following:

**Anykey answer** – Select whether pressing any key answers a call.

**Automatic redial** – Select whether to redial a number automatically if the number you are calling is busy.

**Speed dialling** – Turn speed dialling on or off.

**Calling card** – Store up to four calling card numbers to make long distance calls quickly.

**Abbreviated dialling** – Save a five or six digit prefix that allows you to make a call by entering the last five or four digits.

## Settings

**International prefix** – Edit the prefix for calling international direct dialled numbers. When you are dialling a number and you enter + before the number, the international prefix is automatically used.

**Data/fax calls** – Display the data rate for data calls.

**Call summary** – Select whether the device displays a summary of call information at the end of a call.

**Show call time displ.** – Select whether to show the elapsed time when a call is in progress.

**Slide call handling** – Select whether opening the slide answers a call, and whether closing the slide ends a call.

**Ringtone no caller ID** – Turn this feature on or off, or set it by network.

### ■ Phone settings

To customise your phone settings, select **Menu > Settings > Phone** and from the following:

**Language settings** – Set the language of your phone menu and display.

**Touch key settings** – Set sensitivity, vibration strength, and vibration pattern for the left and right selection keys, the call key, and the end key, or turn selection key vibration off.

**Memory status** – View the amount of memory used and the remaining memory on the device and the memory card (if inserted).

**Automatic keyguard** – Turn automatic keyguard on or off. See "Keyguard", p. 20.

**Voice commands** – You can use voice commands to quickly access menu functions. See "Voice commands", p. 62

**DTMF tones** – Select settings for DTMF tones. These are the tones produced by your device when you are dialling a number. They are commonly used by automated services such as telephone banking and help desks.

**Start-up tone** – Select whether a tone is played when you switch your device on.



## Settings

**Switch off tone** – Select whether a tone is played when you switch your device off.

**Welcome note** – Edit the welcome note that is displayed when you switch your device on.

**Slide close handling** – Choose the action when the slide is closed.

**Flight query** – Select whether to display a prompt to activate the Flight profile when you switch your device on.

**Confirm UIM actions** – Show the confirmation messages sent between your phone and the network when you are using the UIM services.

**Help text activation** – Select whether a short help text is displayed for certain menu items.

### ■ Carrier settings

To configure settings for the browser and WAP, select **Menu > Settings > Carrier settings** > an operator and from the available options.

### ■ Connectivity

#### Bluetooth connectivity

You can connect wirelessly to other compatible devices with Bluetooth technology. Compatible devices may include mobile devices, computers, and accessories such as headsets and car kits. You can use Bluetooth connectivity to send images, video clips, music and sound clips, and notes; and connect wirelessly to your compatible PC (for example, to transfer files).

This device is compliant with Bluetooth Specification 2.0 + EDR supporting the following profiles: Advanced Audio Distribution Profile, Audio/Video Control Transport, Audio/Video Remote Control Profile, Dial-up Networking, File Transfer Profile, Generic Audio/Video Distribution Profile, Hands Free Profile 1.5, Mono Headset, Object Push Profile, and Phone Book Access Profile. To ensure interoperability between other devices supporting Bluetooth technology, use Nokia

## Settings

approved accessories for this model. Check with the manufacturers of other devices to determine their compatibility with this device.

Features using Bluetooth technology increase the demand on battery power and reduce the battery life.

### Security tips

- Operating the device in hidden mode is a safer way to avoid malicious software.
- Do not accept Bluetooth connectivity from sources you do not trust.
- Alternatively, switch off the Bluetooth function. This does not affect other functions of the device.

### Set up Bluetooth connectivity

To turn on Bluetooth connectivity, select [Menu](#) > [Settings](#) > [Connectivity](#) > [Bluetooth](#) > [Bluetooth](#) > [On](#).

To allow your device to be found by other devices with Bluetooth wireless technology, select [My phone's visibility](#) > [Permanent visible](#). To allow visibility for a limited period, select [Temporary visible](#). To hide your device from other devices, select [Hidden](#).

To edit the name shown to other devices using Bluetooth connectivity, select [My phone's name](#).

### Connect a Bluetooth audio device

Select [Menu](#) > [Settings](#) > [Connectivity](#) > [Bluetooth](#) > [Search audio enhanc](#) and the device that you want to connect.

### View the list of your bluetooth connection

To view active Bluetooth connections, select [Menu](#) > [Settings](#) > [Connectivity](#) > [Bluetooth](#) > [Active devices](#). To disconnect a connection, select a device and [Disconnect](#).

### Transfer data using pairing

To enable data transfer between your device and another device with Bluetooth connectivity, you need to set up an association (pairing). To pair with a new device for the first time, you must enter the passcode of 1-16 numeric characters agreed with you and the owner of the device.

## Settings

Select **Menu** > **Settings** > **Connectivity** > **Bluetooth** > **Paired devices**. To search available devices, select **New**. To connect to a device, highlight a device, select **Pair**, and enter the passcode.

To edit settings for a paired device, select **Menu** > **Settings** > **Connectivity** > **Bluetooth** > **Paired devices**, the device, **Options** > **Settings** and from the following:

**Assign short name** — Assign a short name to the paired device.

**Auto-conn., no conf.** — Select whether to allow your device to connect to the paired device without a confirmation prompt.

### USB data cable

You can transfer data between your device and a compatible PC by using a compatible USB data cable.



**Important:** To make a call, disconnect the USB data cable from the device.

To have the device ask the purpose of the USB cable connection each time the cable is connected, select **Menu** > **Settings** > **Connectivity** > **USB data cable** > **Ask on connection**.

### Nokia PC Suite

You can use Nokia PC Suite to transfer data and files, synchronise information between your device and PC (such as calendar notes and contacts entries), and download music and video clips to your device.

1. After installing Nokia PC Suite on your PC, connect your PC with your device by using a compatible USB data cable.
2. Select **Menu** > **Settings** > **Connectivity** > **USB data cable** > **PC Suite**.

### Media player

You can use Windows Media Player to transfer or synchronise music between a compatible PC and your device.

Media player only works with Windows base operating systems with Windows Media Player 10 or higher.

## Settings

When transferring music, the device is not functioning. The transfer stops when playing a specific music file (MP3, AAC, and WMA). It starts transferring again when the song ends.

1. Connect your PC with your device by using a compatible USB data cable.
2. Select **Menu** > **Settings** > **Connectivity** > **USB data cable** > **Media**.

### Data storage

You can use your device as a USB mass storage device (if a compatible memory card is inserted).

To set the computer to recognise your device as a USB mass storage device, connect your PC with your device by using a compatible USB data cable, and select **Menu** > **Settings** > **Connectivity** > **USB data cable** > **Data storage**.

### ■ Accessory settings

You can configure settings for compatible accessories the device is connected to.

Select **Menu** > **Settings** > **Enhancements** and from the following:

**Headset** – Select the default profile to use when a headset is connected, or select whether calls are answered automatically when a headset is connected.

**Handsfree** – Select the default profile to use when a handsfree accessory is connected, configure lights settings, or select what happens when the device detects that the car ignition is switched on.

**Charger** – Select a default profile to use when a charger is connected.

### ■ Security settings

You can configure security settings for your device, UIM card, memory, and calls.

When calls are restricted, calls may be possible to the official emergency number programmed into your device.

## Settings

To personalise security settings, select **Menu > Settings > Security**, enter the preset lock code 1234, and select from the following:

**PIN code request** – Set your device to ask for your PIN code each time the device is switched on.

**Phone lock** – Lock or unlock the device immediately or when switched on. When the device is locked, you must enter your lock code to use the phone again.

**Allow. no. if lock on** – Enter a number that you can call even when the device is locked.

**Call restrictions** – Allow or block all outgoing or incoming calls or only the numbers you select.

**Security level** – Select a security level for your device and your memory card.

**Access codes** – Change the lock code or PIN code.

### ■ Network settings

You can configure settings for roaming (using other networks than your home network), and digital or analogue mode.

Select **Menu > Settings > Network** and from the following:

**Roaming options** – Select whether to allow roaming when you are out of your home network, and the roaming option you prefer.

**Roam call ring. tone** – Select whether to use a special ringing tone for roaming calls.

**Service change tones** – Select whether to play a tone when you start roaming with another network.

### ■ Network services

You can configure settings for network services. For availability, contact your service provider.

Select **Menu > Settings > Network serv. > Network feature sett.**, enter the feature code from your service provider, and from the following:

## Settings

**Call divert** – Configure call divert settings. You can divert all calls, calls when the line is busy, calls that you do not answer, data calls, or calls when you are out of network coverage.

**Call waiting** – Have the network notify you of an incoming call while you have a call in progress.

**Send my caller ID** – Select whether receiving party can see your number. To view your number, select *My number selection*.

### ■ Restore factory settings

You can reset your phone settings to factory defaults.

1. Select **Menu** > **Settings** > **Rest. factory sett.** and from the following:

**Restore settings only** – Restore all preference settings to default without deleting any personal data.

**Restore all** – Restore all default device settings, and delete all personal data.

2. Select **Continue**, enter the lock code, and select **OK**. See "Security settings", p. 44.

### ■ Phone details

To view details of your device, select **Menu** > **Settings** > **Phone details** and from the available options.

## 9. Gallery



In this menu you can manage images, video clips, music files, themes, graphics, tones, recordings, and received files. You can use a compatible microSD card to extend the memory capacity.

### Digital rights management

Content owners may use different types of digital rights management (DRM) technologies to protect their intellectual property, including copyrights. This device uses various types of DRM software to access DRM-protected content. With this device you can access content protected with WMDRM and OMA DRM 1.0. If certain DRM software fails to protect the content, content owners may ask that such DRM software's ability to access new DRM-protected content be revoked. Revocation may also prevent renewal of such DRM-protected content already in your device. Revocation of such DRM software does not affect the use of content protected with other types of DRM or the use of non-DRM-protected content.

Digital rights management (DRM) protected content comes with an associated activation key that defines your rights to use the content.

If your device has OMA DRM-protected content, to back up both the activation keys and the content, use the backup feature of Nokia PC Suite. Other transfer methods may not transfer the activation keys which need to be restored with the content for you to be able to continue the use of OMA DRM-protected content after the device memory is formatted. You may also need to restore the activation keys in case the files on your device get corrupted.

If your device has WMDRM protected content, both the activation keys and the content will be lost if the device memory is formatted. You may also lose the activation keys and the content if the files on your device get corrupted. Losing the activation keys or the content may limit your ability to use the same content on your device again. For more information, contact your service provider.

## Gallery

### ■ Gallery folders

To set how folders and files in Gallery are displayed, select **Menu** > **Gallery** > **Options** > **Type of view** or **Sort**.

To add a new folder to Gallery, select **Menu** > **Gallery** > **Options** > **Add folder**.

### ■ Memory card

You can configure settings for a memory card that is installed in your device. To change memory card settings, select **Menu** > **Gallery** > **Options** > **Rename mem. card** or **Format mem. card**. See "microSD card", p. 12.

### ■ Use files to personalise your device

To view and edit an image, select **Menu** > **Gallery** > **Images**, an image, **Open** > **Options** and from the available options.

To use an image as a wallpaper, screen saver, or contact image, select **Menu** > **Gallery** > **Images**, an image, **Options** > **Use Image** and from the available options.

To use a video clip as a wallpaper, screen saver, call video, or contact video, select **Menu** > **Gallery** > **Video clips**, a video clip, **Options** > **Use video clip** and from the available options.

To apply a theme, select **Menu** > **Gallery** > **Themes**, a theme, and **Apply**. See "Themes", p. 37.

### ■ Work with files

To edit a file, scroll to a file, select **Options** and from the available options.

To move multiple files, scroll to the files, and select **Options** > **Mark**. Select **Mark** to continuously choose other files, and then select **Options** > **Move marked**.

To delete a file, scroll to a file, and select **Options** > **Delete**.



## Gallery

To delete multiple files, scroll to the files, and select **Options** > **Mark**. Select **Mark** to continuously choose other files, and then select **Options** > **Delete marked**.

To send a file, scroll to a file, and select **Options** > **Send** > **E-mail message** or **Via Bluetooth**.

To send multiple files, scroll to the files, and select **Options** > **Mark**. Select **Mark** to continuously choose other files, and then select **Options** > **Send marked** and from the available options.

To view details of a file, scroll to a file, and select **Options** > **Details**.

### ■ Memory Status

To check the memory status of phone and memory card (if inserted), select **Menu** > **Gallery** > **Options** > **Memory status**.



C a m e r a



## 10. Camera

---

You can use the device to capture images or record video clips with the built-in 3-megapixel camera.

Keep a safe distance when using the flash. Do not use the flash on people or animals at close range. Do not cover the flash while taking a picture.

### ■ Capture an image

Your device supports an image capture resolution of 2048 x 1536 pixels, and produce images in JPEG format.

1. In the standby mode, press the camera key or select **Menu > Media > Camera** to activate the camera.
2. To capture an image, press the camera key or select **Capture**.
3. To delete the image you have captured, select **Delete**. To use the picture, select **Options** and from the following:
  - Send** – Send the image in an e-mail message or using Bluetooth connectivity.
  - Attach to contact** – Set the image to display when the contact you select calls you.
  - Rename** – Rename the image.
  - Delete** – Discard the image.
  - New image** – Return to the camera mode.
  - Open Gallery** – Save the image in Gallery. You can set it as a wallpaper or screensaver, or use it in other ways. See "Gallery", p. 47.

### ■ Record a video clip

Your device supports a video record resolution of 320 x 240 pixels, and produce video clips in 3g2 format.

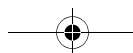
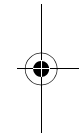
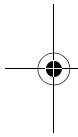

## C a m e r a

1. In the standby mode, press the camera key or select **Menu > Media > Camera** to open the viewfinder, and then scroll up or down to switch to the video mode.
2. To record a video clip, press the camera key or select **Record**. Press the volume keys to zoom in or out. To pause recording, select **Pause**. To resume recording, select **Continue**.
3. To stop recording, select **Stop**. The multimedia player opens. To play the video clip, select **Play**. To pause the video clip, select **Pause**. To delete or use the video clip, select **Options** and from the following:
  - Delete** – Discard the video clip.
  - New video clip** – Return to the video mode.
  - Send** – Send the video clip in an e-mail message or using Bluetooth connectivity.
  - Rename** – Rename the video clip.
  - Open Gallery** – Save the video clip in Gallery. You can set it as a screensaver or incoming call video, or use it in other ways. See "Gallery", p. 47.

### ■ Camera options

You can control appearance and other options for capturing images and recording video clips. Select **Menu > Media > Camera > Options** and from the following options.

**Video or Still image** – Switch between the camera mode and video mode.

**Brightness** – Control the brightness level for images you capture (camera mode only).

**Night mode on or Night mode off** – Enhance quality of images you capture at night (camera mode only).

**Mute or Unmute** – Select whether sound is recorded for video clips (video mode only).

**Flash on or Flash off** – Turn the camera flash on or off (camera mode only).



## C a m e r a



*Self-timer* – Select from the available time periods (camera mode only).

*Effects* – Select from various colour and other effects for the images or video clips you capture.

*White balance* – Select the type of light source you are using.

*Image sequence on* or *Image sequence off* – Take a sequence of five images (camera mode only).

*View previous* – View the previous image or video clip you captured.

*Open Gallery* – Go to Gallery to save or use your images or video clips. See "Gallery", p. 47.

*Settings* – Configure resolution and image quality, image preview time (how long a new image is displayed before returning to the camera mode), camera sounds, the default title for images or video clips you capture, the storage memory (device memory, memory card, or folders in Gallery) and whether the camera opens in the camera mode or video mode.

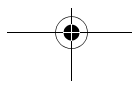
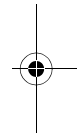
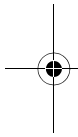

## 11. Media



**Warning:** Listen to music at a moderate level. Continuous exposure to high volume may damage your hearing. Do not hold the device near your ear when the loudspeaker is in use, because the volume may be extremely loud.

### ■ Music player

Music player supports file formats such as AAC and MP3. Music player does not necessarily support all features of a file format or all the variations of file formats.

#### Transfer music

You can transfer music from a compatible PC using Nokia PC suite, Windows Media Player, or Bluetooth connectivity (see "Bluetooth connectivity", p. 41). For information about transferring music with Nokia PC suite and Windows Media Player, see the Nokia PC Suite user guide and corresponding Windows Media Player guides and helps.

To refresh the library after you have updated the song selection in your device, select **Menu** > **Media** > **Music player** > **Options** > **Update library** after all the music files are transferred.

#### Play music

To open music player, select **Menu** > **Media** > **Music player** > **Go to Music player**. The details of the first track on the default playlist are shown. Open the media keys under the 2-way slide, and select from the following:

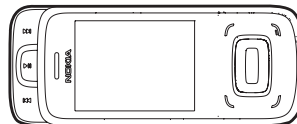

- To play, press **▶||**.
- To adjust the volume level, press the volume key up or down.
- To pause the playing, press **▶||** again.

## Media

- To stop the playing, press and hold the end key.
- To skip to the next track, press **▶▶**.
- To rewind to the beginning of the previous track, press **◀◀**.
- To fast forward the current track, press and hold **▶▶**, and release the key at the position you want.
- To rewind the current track, press and hold **◀◀**.
- To mute audio, select **Options > Mute audio**.
- To play music using a currently connected Bluetooth audio device, select **Options > Play via Bluetooth**.
- To configure play settings, select **Options > Settings** and from the following:
  - Shuffle** – Play songs from the current playlist in a random order.
  - Repeat** – Repeat the current song, or the whole playlist.
  - Audio effects** – Modify the tone of music playback. Select one of the preset settings, or customise your own settings.
  - Speaker type** – Select a speaker type for a 3D audio effect.
  - Music player theme** – Select a colour theme for the music player.

## Music menu

To view all the music available in the device and compatible memory card (if inserted), select **Menu > Media > Music player** and from the following options:

- To view all music, select **All songs**.
- To view and manage playlists, select **Playlists**.
- To view sorted music, select **Artists**, **Albums**, or **Genres**.
- To view and play video clips, select **Videos**.

### Create a new playlist

Select **Menu > Media > Music player > Playlists > Create playlist**, enter a name and select **OK**.

### Default playlists

*Now playing* – The currently playing playlist.

*Most played* – The songs you play most often.

*Recently added* – The most recently added songs.

*Recently played* – Recently played songs.

To play a playlist, scroll to the playlist and select **Play**. See "Play music", p. 53.

### Add songs to playlists

To add a song or video clip to a playlist, select the song or video clip and **Options** > *Add to playlist*. To add all songs to a playlist, select *All songs* > **Options** > *Add to playlist* > a desired playlist > **Add**.

### Manage a list

To manage songs in a playlist, scroll to the playlist, select **Options** > *Open* > **Options** and from the following:

*Organise list* – Change the order of songs in the list.

*Send* – Send the current song in an e-mail message or using Bluetooth connectivity.

*Remove* – Remove the currently playing song from the playlist.

*Add to playlist* – Add the currently playing song to another playlist. See "Add songs to playlists", p. 55.

*Song details* – View details about the currently playing song.

### Download music and video clips

Select **Menu** > *Media* > *Music player* > **Options** > *Downloads* > *Bookmarks* and scroll to the desired bookmark (if set).

Alternatively, when the music player is on, select **Options** > *Downloads* > *Bookmarks* and scroll to the desired bookmark (if set).

### ■ Media player

To view images, including animated images, and play video and audio files, select **Menu** > *Media* > *Media player* and from the following:

## Media

**Open Gallery** – Select a file from Gallery to open in the media player. See "Gallery", p. 47.

**Go to address** – Browse for streaming audio or video.

**FF/Rew interval** – Set the interval at which video or audio will fast-forward or rewind. Select from the available intervals, or enter an interval in MM:SS format.

## ■ Stereo FM radio

The radio depends on an antenna other than the wireless device antenna. A compatible headset or accessory needs to be attached to the device for the radio to function properly.

### Listen to the radio

1. Connect a compatible headset to the device.
2. Select **Menu > Media > Radio**. The station location number, the name of the radio station (if you have saved the station), and the frequency of the radio station are displayed.
3. If you have saved radio stations, scroll up or down to the station you want to listen to.

You can also select a radio station by pressing the corresponding number keys.



### Tune a radio station

1. When the radio is on, select **◀◀** or **▶▶** to change the radio frequency in steps of 0.1-MHz, or select and hold **◀◀** or **▶▶** to search for a station. Searching stops when a station is found. To set the frequency quickly, press and hold **1**, **8**, or **9**, or press the **\*** key.
2. To save the station to a memory location from 1 to 20, select **Options > Save station**.
3. If all stations are set, scroll to the desired memory location and select **Replace**.

You can make or answer a call while listening to the radio. During the call, the radio is muted.





Media

To change a radio station, select  or . To mute the radio, select .

### Recorder

You can record sound with your device and save them to the Recordings folder in Gallery. The maximum length of a recording is three minutes.

#### Record speech or sound

1. Select **Menu** > **Media** > **Recorder** >  (or press the voice command key in the standby mode). The start tone indicates that recording has begun.
2. To finish recording, select . Your recording is saved in **Gallery** > **Recordings**.

### Audio effects

You can select audio effects for listening to files on your device. Select **Menu** > **Media** > **Audio effects** and from the available options.

### Speaker type

You can select a speaker type for a 3D audio effect. Select **Menu** > **Media** > **Speaker type** and from the available options.

Organiser

## 12. Organiser



Use the various tools and applications to customise your phone and use your phone as an organiser and a personal digital assistant.

### ■ Alarm clock

Select **Menu** > **Organiser** > **Alarm clock**, and set the repeat interval, alarm tone, and snooze time as needed. When an alarm is set,  is displayed in the standby mode.

The alarm sounds even when the device is switched off. Select **Stop** to end the alarm, or **Snooze** to stop for the time you set in **Snooze time-out**; and then resumes.

To turn off an alarm, select **Menu** > **Organiser** > **Alarm clock**, scroll to the **Alarm:** field, and select **Change** > **Off** > **Options** > **Save**.

### ■ Calendar

Select **Menu** > **Organiser** > **Calendar**.

The current day is indicated by a frame. The day scheduled with events is highlighted in bold shape, and the beginning of the note is shown below the calendar. To view the day notes, select **View**.

To view the event in a specific date, select **Options** > **Go to date**, enter the date, and select **OK**.

To configure other settings of the calendar, select **Options** > **Settings** and from the available options.

### Make a calendar note

1. To create a calendar note, select **Menu** > **Organiser** > **Calendar**, highlight the required event date, and **Options** > **Make a note**.
2. Select the event type.
3. Fill in the entry fields you want to complete, and finally select **Save**.

## Organiser

The event information of current date is played in the active standby mode.

### Set an alarm

You can set an alarm for each calendar note. The alarm sounds at the time you set. The alarm stops when you select **View** or **Exit**.

### ■ Notes

You can write and save information in notes and send notes as text messages or using Bluetooth connectivity. Select **Menu > Organiser > Notes**.

To create a note when no notes have been saved, select **Add**, write a note with your keypad, and select **Save**.

To use a note, select the note, **View > Options** and from the available options.

### ■ To-do list

Use the to-do list to keep track of your tasks. You can save a note for a task, and mark the note as done when you have completed it. You can sort notes by priority or by date. Select **Menu > Organiser > To-do list** and from the available options.

### ■ Calculator

The calculator can add, subtract, multiply, divide, calculate squares and square roots, and convert currency values.



**Note:** This calculator has limited accuracy and is designed for simple calculations.

1. Select **Menu > Organiser > Calculator**.
2. Enter the first number in the calculation. Press **#** for a decimal point if necessary.

To add (+), subtract (-), multiply (\*), or divide (/), press \* repeatedly.

To perform a square or square root calculation, select **Options > Square** or **Square root**.

## Organiser

3. Enter the second number in your calculation.
4. Select **Equals** to complete the calculation or **Options** and from the available options.

## Currency converter

You can convert between foreign and domestic currencies.



**Note:** When you change base currency, you must enter new exchange rates because all previously set exchange rates are cleared.

Select **Menu > Organiser > Calculator > Options > Exchange rate** and from the available options.

## Countdown timer

The countdown timer only works when the device is on.

### Normal timer

To activate the countdown timer, select **Menu > Organiser > Countdown timer > Normal timer**, enter the alarm time, and write a note that is displayed when the time expires.

1. To change the countdown time, select **Change time**.
2. To start the timer, select **Start**.
3. To stop the timer, select **Stop timer**.

### Interval timer

1. To have an interval timer with up to 10 intervals started, first enter the intervals.
2. Select **Menu > Organiser > Countdown timer > Interval timer**.
3. To start the timer, select **Start timer > Start**.

Organiser

### Settings

You can select whether the timer automatically continues to the next period. Select **Menu** > **Organiser** > **Countdown timer** > **Settings** > **Contin. to next period** > **Confirm first** or **Automatic**.

### ■ Stopwatch

The stopwatch can be used for elapsed time measurement, such as for a sporting event. The elapsed time is displayed in HH:MM:SS.SS format.

Select **Menu** > **Organiser** > **Stopwatch** and from the following options:

- To measure intermediate times, select **Split timing** > **Start**. Select **Split** every time you want to take an intermediate time.
- To measure lap times, select **Lap timing** > **Start**. Select **Lap** every time you want measure the time from zero.

To stop the watch, select **Stop**. To reset the watch to zero, select **Options** > **Reset** with the watch in stopped mode.

If you press the end key and return to the standby mode, the clock continues to run in the background, and  is displayed.

To return to the stopwatch, select **Menu** > **Organiser** > **Stopwatch** > **Continue**.



**Warning:** Using the stopwatch or allowing it to run in the background when using other features increases the demand on battery power and reduces the battery life.

Voice commands

## 13. Voice commands

Voice commands transform your device into your own virtual personal assistant, allowing you to use your voice to make phone calls, look up contacts, play and control your music, and more.



**Note:** This function can only support English, Spanish and Chinese.

### ■ Activate and use voice commands

To activate voice commands, press and hold the voice command key (see "Your device", p. 16). Select **Menu > Settings > Phone > Voice commands**. The following options are displayed:

**Call <Name or #>** – Say "Call" and a name or a phone number from Contacts. For example, "Call Tom Smith", "Call Tom Smith's cell", or "Call 617 515 212".

**Send Text <Name or #>** – If you give a full-sentence command, such as "Send text to Tom", you are asked to confirm the message and give the contact number. A message based on the message type you requested opens.

**Lookup <Name>** – To retrieve and display information of the contact, say "Lookup" and the name from Contacts (for example, "Lookup Tom").

**Go To <Menu>** – To open the list of menu options on your device and to select the menu item you want, say "Go to", or say a full command with the application name (for example, "Go to Contacts").

**Check <Item>** – Say "Check". You are asked for a list of items. Say "Check status" to hear all status information for your device, including network status, voicemail, messages, number of missed calls, time and date, battery level, signal strength, and volume.

For detailed instructions on how to use each command, select the command you want and [Help](#).

## ■ Voice Command Settings

You can personalise settings for your voice command functions.

### Command confirmation

When your device is unsure of the name or number you have said, a list of three choices is shown.

To display the choices, press and hold the voice command key, and select [Settings > Confirmation > Automatic or Always Confirm](#).

To display only the best match, press and hold the voice command key, and select [Settings > Confirmation > Never Confirm](#).

### Voice adaptation

You can adapt the system to your voice to improve the accuracy of your voice commands. The adaptation process takes a few minutes. The system will prompt you to say a series of short commands, including different names and numbers.

To use voice adaptation, press and hold the voice command key, and select [Settings > Adaptation > Adapt Voice](#).

### User modes

You can set the system to prompt for information, read out content you select, or sound beeps only.

To use beeps instead of verbal prompts, press and hold the voice command key, and select [Settings > Modes > Expert Mode](#).

To hear verbal prompts for information, press and hold the voice command key, and select [Settings > Modes > Prompt Mode](#).

To hear the system read out the menu items as you navigate, press and hold the voice command key, and select [Settings > Modes > Readout Mode](#).



## Voice commands



### Speakerphone

You can configure how the speakerphone behaves when voice recognition is activated.

To use the default settings, press and hold the voice command key, and select *Settings > Speakerphone > Automatic*.

To use the speakerphone for all outgoing audio, press and hold the voice command key, and select *Settings > Speakerphone > Always On*.

To use the internal speakerphone for all outgoing audio, press and hold the voice command key, and select *Settings > Speakerphone > Always Off*.

### About the voice command

To view more information about the voice command, press and hold the voice command key, and select *Settings > About*.

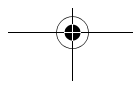
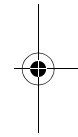
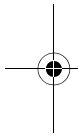



## 14. Extras



Extras includes a group of extra features, including games, a converter to convert measures from one unit to another, and a world clock to see the current time in four locations.

### ■ Games

Select **Menu** > **Extras** > **Games** to access the games on your device.

### ■ Collection

#### Converter II

Converter II has limited accuracy, and rounding errors may occur.

To convert measures from one unit to another, select **Menu** > **Extras** > **Collection** > **Converter II**.

To change the settings, select **Options** and from the following:

**Set conversion** – Select the unit to convert.

**Clear all** – Clear the display.

**Reverse conversion** – Reverse the units being converted. For example, pound to kilogram becomes kilogram to pound.

**Configure** – Select the default units to convert.

**Instructions** – View further instructions.

**Change sign** – Add or remove the minus sign after a unit has been converted.

#### World clock

World clock allows you to see the current time in four locations. To configure the locations, to set the time zone and time format, or to view instructions, select **Menu** > **Extras** > **Collection** > **World clock** > **Options** and from the available options.

## Battery and charger information

## 15. Battery and charger information

Your device is powered by a rechargeable battery. The battery intended for use with this device is BL-4C. Nokia may make additional battery models available for this device. This device is intended for use when supplied with power from the following chargers: AC-6. The exact charger model number may vary depending on the type of plug. The plug variant is identified by one of the following: E, EB, X, AR, U, A, C, or UB.

The battery can be charged and discharged hundreds of times, but it will eventually wear out. When the talk and standby times are noticeably shorter than normal, replace the battery. Use only Nokia approved batteries, and recharge your battery only with Nokia approved chargers designated for this device. Use of an unapproved battery or charger may present a risk of fire, explosion, leakage, or other hazard.

If a battery is being used for the first time or if the battery has not been used for a prolonged period, it may be necessary to connect the charger, then disconnect and reconnect it to begin charging the battery. If the battery is completely discharged, it may take several minutes before the charging indicator appears on the display or before any calls can be made.

Always switch the device off and disconnect the charger before removing the battery.

Unplug the charger from the electrical plug and the device when not in use. Do not leave a fully charged battery connected to a charger, since overcharging may shorten its lifetime. If left unused, a fully charged battery will lose its charge over time.

Always try to keep the battery between 15°C and 25°C (59°F and 77°F). Extreme temperatures reduce the capacity and lifetime of the battery. A device with a hot or cold battery may not work temporarily. Battery performance is particularly limited in temperatures well below freezing.

Do not short-circuit the battery. Accidental short-circuiting can occur when a metallic object such as a coin, clip, or pen causes direct connection of the positive (+) and negative (-) terminals of the battery.

### Battery and charger information

(These look like metal strips on the battery.) This might happen, for example, when you carry a spare battery in your pocket or purse. Short-circuiting the terminals may damage the battery or the connecting object.

Do not dispose of batteries in a fire as they may explode. Batteries may also explode if damaged. Dispose of batteries according to local regulations. Please recycle when possible. Do not dispose as household waste.

Do not dismantle, cut, open, crush, bend, deform, puncture, or shred cells or batteries. In the event of a battery leak, do not allow the liquid to come in contact with the skin or eyes. In the event of such a leak, flush your skin or eyes immediately with water, or seek medical help.

Do not modify, remanufacture, attempt to insert foreign objects into the battery, or immerse or expose it to water or other liquids.

Improper battery use may result in a fire, explosion, or other hazard. If the device or battery is dropped, especially on a hard surface, and you believe the battery has been damaged, take it to a service centre for inspection before continuing to use it.

Use the battery only for its intended purpose. Never use any charger or battery that is damaged. Keep your battery out of the reach of small children.

#### **Nokia battery authentication guidelines**

Always use original Nokia batteries for your safety. To check that you are getting an original Nokia battery, purchase it from a Nokia authorised service centre, and inspect the hologram label using the following steps:

Successful completion of the steps is not a total assurance of the authenticity of the battery. If you have any reason to believe that your battery is not an authentic, original Nokia battery, you should refrain from using it, and take it to the nearest authorised Nokia service point or dealer for assistance. Your authorised Nokia service point or dealer will inspect the battery for authenticity. If authenticity cannot be verified, return the battery to the place of purchase.

## Battery and charger information

### Authenticate hologram

1. When you look at the hologram on the label, you should see the Nokia connecting hands symbol from one angle and the Nokia Original Enhancements logo when looking from another angle.
2. When you angle the hologram left, right, down and up, you should see 1, 2, 3 and 4 dots on each side respectively.

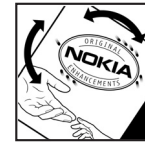
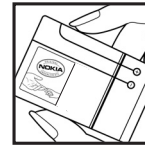

Successful completion of the steps is not a total assurance of the authenticity of the battery. If you have any reason to believe that your battery is not an authentic, original Nokia battery, you should refrain from using it, and take it to the nearest Nokia authorised service centre or dealer for assistance. If authenticity cannot be verified, return the battery to the place of purchase.

### What if your battery is not authentic?

If you cannot confirm that your Nokia battery with the hologram on the label is an authentic Nokia battery, please do not use the battery. Take it to the nearest authorised Nokia service centre or dealer for assistance. The use of a battery that is not approved by Nokia may be dangerous and may result in poor performance and damage to your device and its accessories. It may also invalidate any approval or warranty applying to the device.

To find out more about original Nokia batteries, visit [www.nokia.com/battery](http://www.nokia.com/battery).

## Care and maintenance

Your device is a product of superior design and craftsmanship and should be treated with care. The following suggestions will help you protect your warranty coverage.

- Keep the device dry. Precipitation, humidity, and all types of liquids or moisture can contain minerals that will corrode electronic circuits. If your device does get wet, remove the battery, and allow the device to dry completely before replacing it.
- Do not use or store the device in dusty, dirty areas. Its moving parts and electronic components can be damaged.
- Do not store the device in hot areas. High temperatures can shorten the life of electronic devices, damage batteries, and warp or melt certain plastics.
- Do not store the device in cold areas. When the device returns to its normal temperature, moisture can form inside the device and damage electronic circuit boards.
- Do not attempt to open the device other than as instructed in this guide.
- Do not drop, knock, or shake the device. Rough handling can break internal circuit boards and fine mechanics.
- Do not use harsh chemicals, cleaning solvents, or strong detergents to clean the device.
- Do not paint the device. Paint can clog the moving parts and prevent proper operation.
- Use only the supplied or an approved replacement antenna. Unauthorised antennas, modifications, or attachments could damage the device and may violate regulations governing radio devices.
- Use chargers indoors.
- Always create a backup of data you want to keep, such as contacts and calendar notes.
- To reset the device from time to time for optimum performance, power off the device and remove the battery.

These suggestions apply equally to your device, battery, charger, or any accessory. If any device is not working properly, take it to the nearest authorised service facility for service.

Care and maintenance



**Disposal**

The crossed-out wheeled-bin symbol on your product, literature, or packaging reminds you that all electrical and electronic products, batteries, and accumulators must be taken to separate collection at the end of their working life. This requirement applies to the European Union and other locations where separate collection systems are available. Do not dispose of these products as unsorted municipal waste.

By returning the products to collection you help prevent uncontrolled waste disposal and promote the reuse of material resources. More detailed information is available from the product retailer, local waste authorities, national producer responsibility organizations, or your local Nokia representative. For the product Eco-Declaration or instructions for returning your obsolete product, go to country-specific information at [www.nokia.com](http://www.nokia.com).

## Additional safety information

## Additional safety information

### ■ Small children

Your device and its accessories may contain small parts. Keep them out of the reach of small children.

### ■ Operating environment

This device meets RF exposure guidelines when used either in the normal use position against the ear or when positioned at least 2.2 centimetres (7/8 inch) away from the body. When a carry case, belt clip or holder is used for body-worn operation, it should not contain metal and should position the device the above-stated distance from your body.

To transmit data files or messages, this device requires a quality connection to the network. In some cases, transmission of data files or messages may be delayed until such a connection is available. Ensure the above separation distance instructions are followed until the transmission is completed.

Parts of the device are magnetic. Metallic materials may be attracted to the device. Do not place credit cards or other magnetic storage media near the device, because information stored on them may be erased.

### ■ Medical devices

Operation of any radio transmitting equipment, including wireless phones, may interfere with the functionality of inadequately protected medical devices. Consult a physician or the manufacturer of the medical device to determine if they are adequately shielded from external RF energy or if you have any questions. Switch off your device in health care facilities when any regulations posted in these areas instruct you to do so. Hospitals or health care facilities may be using equipment that could be sensitive to external RF energy.

### Implanted medical devices

Manufacturers of medical devices recommend that a minimum separation of 15.3 centimetres (6 inches) should be maintained between a wireless device and an implanted medical device, such as a pacemaker or implanted cardioverter defibrillator, to avoid potential interference with the medical device. Persons who have such devices should:

- Always keep the wireless device more than 15.3 centimetres (6 inch) from the medical device when the wireless device is turned on.
- Not carry the wireless device in a breast pocket.

#### Additional safety information

- Hold the wireless device to the ear opposite the medical device to minimise the potential for interference.
- Turn the wireless device off immediately if there is any reason to suspect that interference is taking place.
- Read and follow the directions from the manufacturer of their implanted medical device.

If you have any questions about using your wireless device with an implanted medical device, consult your health care provider.

#### ■ Vehicles

RF signals may affect improperly installed or inadequately shielded electronic systems in motor vehicles such as electronic fuel injection systems, electronic antiskid (antilock) braking systems, electronic speed control systems, and air bag systems. For more information, check with the manufacturer, or its representative, of your vehicle or any equipment that has been added.

Only qualified personnel should service the device or install the device in a vehicle. Faulty installation or service may be dangerous and may invalidate any warranty that may apply to the device. Check regularly that all wireless device equipment in your vehicle is mounted and operating properly. Do not store or carry flammable liquids, gases, or explosive materials in the same compartment as the device, its parts, or accessories. For vehicles equipped with an air bag, remember that air bags inflate with great force. Do not place objects, including installed or portable wireless equipment in the area over the air bag or in the air bag deployment area. If in-vehicle wireless equipment is improperly installed and the air bag inflates, serious injury could result.

Using your device while flying in aircraft is prohibited. Switch off your device before boarding an aircraft. The use of wireless teledevices in an aircraft may be dangerous to the operation of the aircraft, disrupt the wireless telephone network, and may be illegal.

#### ■ Potentially explosive environments

Switch off your device when in any area with a potentially explosive atmosphere, and obey all signs and instructions. Potentially explosive atmospheres include areas where you would normally be advised to turn off your vehicle engine. Sparks in such areas could cause an explosion or fire resulting in bodily injury or even death. Switch off the device at refuelling points such as near gas pumps at service stations. Observe restrictions on the use of radio equipment in fuel depots, storage, and distribution areas; chemical plants; or where blasting operations are in progress. Areas with a potentially explosive atmosphere are



### Additional safety information

often, but not always, clearly marked. They include below deck on boats, chemical transfer or storage facilities and areas where the air contains chemicals or particles such as grain, dust, or metal powders. You should check with the manufacturers of vehicles using liquefied petroleum gas (such as propane or butane) to determine if this device can be safely used in their vicinity.

#### ■ Emergency calls



**Important:** This device operates using radio signals, wireless networks, landline networks, and user-programmed functions. If your device supports voice calls over the internet (internet calls), activate both the internet calls and the cellular phone. The device will attempt to make emergency calls over both the cellular networks and through your internet call provider if both are activated. Connections in all conditions cannot be guaranteed. You should never rely solely on any wireless device for essential communications like medical emergencies.

#### To make an emergency call:

1. If the device is not on, switch it on. Check for adequate signal strength. Depending on your device, you may also need to complete the following:
  - Insert a UIM card if your device uses one.
  - Remove certain call restrictions you have activated in your device.
  - Change your profile from offline or flight profile mode to an active profile.
2. Press the end key as many times as needed to clear the display and ready the device for calls.
3. Enter the official emergency number for your present location. Emergency numbers vary by location.
4. Press the call key.

When making an emergency call, give all the necessary information as accurately as possible. Your wireless device may be the only means of communication at the scene of an accident. Do not end the call until given permission to do so.

#### ■ Certification information (SAR)

##### This mobile device meets guidelines for exposure to radio waves.

Your mobile device is a radio transmitter and receiver. It is designed not to exceed the limits for exposure to radio waves recommended by international guidelines. These guidelines were developed by the independent scientific organization ICNIRP and include safety margins designed to assure the protection of all persons, regardless of age and health.

### Additional safety information

The exposure guidelines for mobile devices employ a unit of measurement known as the Specific Absorption Rate or SAR. The SAR limit stated in the ICNIRP guidelines is 2.0 watts/kilogram (W/kg) averaged over 10 grams of tissue. Tests for SAR are conducted using standard operating positions with the device transmitting at its highest certified power level in all tested frequency bands. The actual SAR level of an operating device can be below the maximum value because the device is designed to use only the power required to reach the network. That amount changes depending on a number of factors such as how close you are to a network base station. The highest SAR value under the ICNIRP guidelines for use of the device at the ear is 0.56 W/kg.

Use of device accessories may result in different SAR values. SAR values may vary depending on national reporting and testing requirements and the network band. Additional SAR information may be provided under product information at [www.nokia.com](http://www.nokia.com).

### Battery Information

This section provides information about battery charging times with the AC-6 charger, and talk and standby times. Be aware that the information in this section is subject to change. For more information, contact your service provider.



**Important:** Battery talk and standby times are estimates only and depend on signal strength, network conditions, features used, battery age and condition, temperatures to which battery is exposed, use in digital mode, and many other factors. The amount of time a device is used for calls will affect its standby time. Likewise, the amount of time that the device is turned on and in the standby mode will affect its talk time.

### Charging times

Charger options	AC-6
BL-4C 860 mAh Li-Ion battery	Up to 3 hours 30 minutes

## Index

---

### A

accessories 8  
alarm clock 58

### B

back cover  
  removing 10  
  replacing 12  
battery  
  charging 13  
  charging times 74  
  information 66  
  removing 10  
  replacing 11  
  talk and standby times 74  
Bluetooth connectivity 41

### C

calculator 59  
calendar 58  
call settings 39  
calls  
  answering 21  
  making 21  
camera  
  capturing images 50  
  recording video clips 50  
care and maintenance 69  
charger  
  charging times 74  
  connecting 13  
  information 66  
connectivity 41  
contacts list  
  deleting 32  
converter 65  
countdown timer 60  
currency converter 60

### D

date and time settings 38  
display settings 34

75

### E

e-mail 27  
emergency calls 73  
English text entry 23  
extras 65

### F

factory settings  
  restoring 46

### G

gallery 47  
games 65

### H

headset 14

### I

images  
  capturing 50  
inbox  
  e-mail 29  
  text messages 25  
indicators and icons 19

### K

keyguard 20  
keys and parts 16

### L

log 33  
loudspeaker 22

### M

media 56  
media player 55  
memory status 49  
messages  
  e-mail 29  
  replying to 25, 29

text 25  
voice 27  
writing and sending 25, 29  
microSD card 12  
music  
  playing 53  
  transferring 53  
music player 53  
my shortcuts 38

## N

network services 7, 45  
network settings 45  
notes 59

## O

organiser 58

## P

PC suite 43  
phone details 46  
phone settings 40  
profiles 34

## R

roaming 45

## S

safety 6, 71  
security settings 44

settings 34  
special characters 24  
speed dials 31  
standby mode 18  
start screen 18  
stereo FM radio 56  
stopwatch 61  
switching the device on and off 13

## T

talk and standby times 74  
text entry  
  English 23  
  special characters 24  
themes 37  
to-do list 59  
tone settings 37

## U

UIM card 11  
USB data cable 43

## V

voice commands 62  
voice recorder 57

## W

world clock 65  
wrist strap 15